

Power Combiner/Splitter

Electrical Specifications

Frequency Band	758-960 MHz
Input Power (Max.)	10W as splitter, 5W as combiner
Insertion Loss (Max. / Typ.)	3.5 / 3.15 dB
VSWR (Max.)	1.5:1
Impedance (Nom.)	50 Ω
RF Connectors	N Female

Mechanical Specifications

Finish	Yellow Chem Film
Overall Size (HxWxD)	1.5" x 2.75" x 3.5" (38 x 70 x 89 mm)
Net Weight	0.35 lbs (0.2 kg)
Ship Weight	1 lbs (0.5 kg)

Environmental Specifications

Operating Temp. Range	-20 to +50 °C
-----------------------	---------------

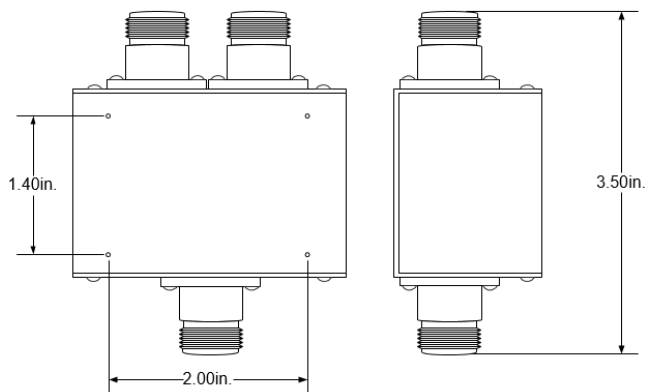
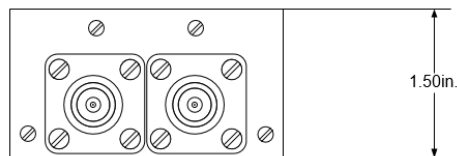
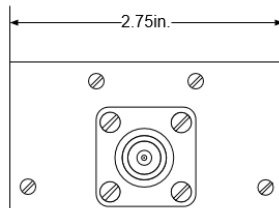

EMR Power Splitters/Combiners offer frequency ranges from 30 MHz to 960 MHz with low insertion loss and excellent VSWR. Other features include high isolation, excellent amplitude and phase balance, and rugged packaging. All EMR power dividers are backed by 5-Year Warranty.

Product Features

- Wideband
- High isolation
- Low loss